

# WCHD75-300 系列 DC/DC 一体化电源 技术指标书

Ver:1.0

北京伟仕天成科技有限公司

## 典型性能 Features

- ◆ 75~300 瓦功率输出
- ◆ 宽电压输入
- ◆ 输出短路保护
- ◆ 高隔离耐压
- ◆ 接线端子出线方式
- ◆ 金属外壳，安装方便
- ◆ 宽温导热设计，适用于石油、铁路、雷达以及车载等相关军用领域



## 电气特性 Electrical Specifications

输入特性 Input	Min	Type	Max	Notes
输入电压范围 Input Voltage Range	9V	12V	18V	24V输入宽范围，尾缀加W
	18V	24V	36V	
	9V	24V	36V	
	36V	48V	72V	
	18V	48V	72V	48V输入宽范围，尾缀加W
	66V	110V	160V	
	43V	110V	160V	110V输入宽范围，尾缀加W
控制功能（默认为正逻辑控制方式） ON/OFF Control		开启 ON		CNT 悬空或接TTL高电平 CNT pin left open or CNT pin connected to TTL logic high
		关断 OFF		CNT 低电平或与-Vin 相连 CNT pin is at a logic low
输入欠压保护 Input. Under-voltage Lockout	6V		9V	9-18V/9-36V输入
	14V		18V	18-36V/18-72V输入
	28V		36V	36-72V输入
	52V		66V	66-160V输入
	36V		45V	45-160V输入
启动延时时间 Start-up Delay Time		20mS		
输出特性 Output	Min	Type	Max	Notes
输出电压精度 Set point Accuracy			±2%	
负载效应 Load Regulation			±1%	
源效应 Line Regulation			±1%	

输出电压调节 Output Voltage TRIM Range			±10%	
纹波噪声 (注 1) Ripple and Noise			50mV	Vo≤5V Other Vo≥36V
			100mV	
			200mV	
动态响应 Dynamic Response	±5% Vo Pk deviation 400μS settling time			25~50~25% load 75~50~75% load
输出过流保护 Current Limit Threshold	110%		160%	
输出过压保护 Over-voltage Protection	110%		130%	
短路保护 Short-Circuit Protection	短路自恢复 Automatic Recovery			
<b>综合特性 General</b>	<b>Min</b>	<b>Type</b>	<b>Max</b>	<b>Notes</b>
隔离电压 (注 2) Isolation Voltage			1500Vdc	输入与输出 Input-Output
			1000Vdc	输入与壳 Input-Case
			500Vdc	输出与壳 Output-Case
开关频率 Switching Frequency		300KHz		
平均故障间隔时间 MTBF		5×10 <sup>5</sup> Hrs		Mil HDBK 217F Tc=25℃
工作壳温 Case Temperature	工业级	-40℃		+90℃
	铁路专用	-40℃		+90℃
	AH、AG 级	-40℃		+90℃
	AHII 级	-55℃		+95℃
储存温度 Storage Temperature	-45℃		+105℃	
相对湿度 Relative Humidity	5%		95%	
传导骚扰 Conducted Emission	GJB151B-2013 GB/T 24338.4-2009			
静电放电 Electrostatic Discharge	GB17626.2/EN61000-4-2 Contact ±6KV			
脉冲群抗扰度 Electrical Fast Transient	GB17626.4/EN61000-4-4 ±2KV perf. Criteria A			
浪涌抗扰度 Surge Immunity	GB17626.5/EN61000-4-5 ±2KV perf. Criteria B			

注 1: 纹波噪声采用 20MHz 带宽、平行线法测试;

注 2: 交流电压测试漏电流为 5mA, 直流电压测试漏电流为 0.5mA; 若铁路专用产品, 输入与输出以及输入与壳两项隔离电压均为 1000Vac/5mA;

**产品型号列表 Product Model List**

型号 Models	输入电压 范围 (Vdc) Input Voltage Range	输出电压 (Vdc) Output Voltage	输出电流 (A) Output current	纹波噪声 (mv) Ripple and noise	典型效率 Efficiency	容性负载 (μF) Max.Capacitor Load
WCHD75-12S3V3	9-18	3.3	15	50	86%	10000
WCHD75-12S5	9-18	5.05	15	50	86%	10000
WCHD75-12S9	9-18	9	8.3	100	85%	2200
WCHD75-12S12	9-18	12	6.3	100	85%	2200
WCHD75-12S15	9-18	15	5	100	85%	2200
WCHD75-12S18	9-18	18	4.2	100	85%	2200
WCHD75-12S24	9-18	24	3.1	100	85%	1000
WCHD75-12S28	9-18	28	2.7	100	85%	1000
WCHD75-12S36	9-18	36	2.1	200	85%	1000
WCHD75-12S48	9-18	48	1.6	200	85%	1000
WCHD75-24S3V3	18-36	3.3	15	50	87%	10000
WCHD75-24S5	18-36	5.05	15	50	87%	10000
WCHD75-24S9	18-36	9	8.3	100	86%	2200
WCHD75-24S12	18-36	12	6.3	100	86%	2200
WCHD75-24S15	18-36	15	5	100	86%	2200
WCHD75-24S18	18-36	18	4.2	100	86%	2200
WCHD75-24S24	18-36	24	3.1	100	86%	1000
WCHD75-24S28	18-36	28	2.7	100	85%	1000
WCHD75-24S36	18-36	36	2.1	200	86%	1000
WCHD75-24S48	18-36	48	1.6	200	86%	1000
WCHD75-48S3V3	36-72	3.3	15	50	87%	10000
WCHD75-48S5	36-72	5.05	15	50	87%	10000
WCHD75-48S9	36-72	9	8.3	100	86%	2200
WCHD75-48S12	36-72	12	6.3	100	86%	2200
WCHD75-48S15	36-72	15	5	100	86%	2200
WCHD75-48S18	36-72	18	4.2	100	86%	2200
WCHD75-48S24	36-72	24	3.1	100	88%	1000

WCHD75-48S28	36-72	28	2.7	100	88%	1000
WCHD75-48S36	36-72	36	2.1	200	86%	1000
WCHD75-48S48	36-72	48	1.6	200	86%	1000
WCHD75-110S3V3	66-154	3.3	15	50	87%	10000
WCHD75-110S5	66-154	5.05	15	50	87%	10000
WCHD75-110S9	66-154	9	8.3	100	86%	2200
WCHD75-110S12	66-154	12	6.3	100	86%	2200
WCHD75-110S15	66-154	15	5	100	86%	2200
WCHD75-110S18	66-154	18	4.2	100	86%	2200
WCHD75-110S24	66-154	24	3.1	100	86%	1000
WCHD75-110S28	66-154	28	2.7	100	85%	1000
WCHD75-110S36	66-154	36	2.1	200	86%	1000
WCHD75-110S48	66-154	48	1.6	200	86%	1000
WCHD100-12S3V3	9-18	3.3	20	50	86%	10000
WCHD100-12S5	9-18	5.05	20	50	86%	10000
WCHD100-12S9	9-18	9	11.1	100	85%	2200
WCHD100-12S12	9-18	12	8.3	100	85%	2200
WCHD100-12S15	9-18	15	6.7	100	85%	2200
WCHD100-12S18	9-18	18	5.6	100	85%	2200
WCHD100-12S24	9-18	24	4.2	100	85%	1000
WCHD100-12S28	9-18	28	3.6	100	85%	1000
WCHD100-12S36	9-18	36	2.8	200	85%	1000
WCHD100-12S48	9-18	48	2.1	200	85%	1000
WCHD100-24S3V3	18-36	3.3	20	50	87%	10000
WCHD100-24S5	18-36	5.05	20	50	87%	10000
WCHD100-24S9	18-36	9	11.1	100	86%	2200
WCHD100-24S12	18-36	12	8.3	100	86%	2200
WCHD100-24S15	18-36	15	6.7	100	86%	2200
WCHD100-24S18	18-36	18	5.6	100	86%	2200
WCHD100-24S24	18-36	24	4.2	100	86%	1000

WCHD100-24S28	18-36	28	3.6	100	85%	1000
WCHD100-24S36	18-36	36	2.8	200	86%	1000
WCHD100-24S48	18-36	48	2.1	200	86%	1000
WCHD100-24S3V3W	9-36	3.3	20	50	86%	10000
WCHD100-24S5W	9-36	5.05	20	50	86%	10000
WCHD100-24S9W	9-36	9	11.1	100	85%	2200
WCHD100-24S12W	9-36	12	8.3	100	85%	2200
WCHD100-24S15W	9-36	15	6.7	100	85%	2200
WCHD100-24S18W	9-36	18	5.6	100	85%	2200
WCHD100-24S24W	9-36	24	4.2	100	85%	1000
WCHD100-24S28W	9-36	28	3.6	100	85%	1000
WCHD100-24S36W	9-36	36	2.8	200	85%	1000
WCHD100-24S48W	9-36	48	2.1	200	85%	1000
WCHD100-48S3V3	36-72	3.3	20	50	87%	10000
WCHD100-48S5	36-72	5.05	20	50	87%	10000
WCHD100-48S9	36-72	9	11.1	100	86%	2200
WCHD100-48S12	36-72	12	8.3	100	86%	2200
WCHD100-48S15	36-72	15	6.7	100	86%	2200
WCHD100-48S18	36-72	18	5.6	100	86%	2200
WCHD100-48S24	36-72	24	4.2	100	88%	1000
WCHD100-48S28	36-72	28	3.6	100	88%	1000
WCHD100-48S36	36-72	36	2.8	200	86%	1000
WCHD100-48S48	36-72	48	2.1	200	86%	1000
WCHD100-48S3V3W	18-72	3.3	20	50	87%	10000
WCHD100-48S5W	18-72	5.05	20	50	87%	10000
WCHD100-48S9W	18-72	9	11.1	100	86%	2200
WCHD100-48S12W	18-72	12	8.3	100	86%	2200
WCHD100-48S15W	18-72	15	6.7	100	86%	2200
WCHD100-48S18W	18-72	18	5.6	100	86%	2200
WCHD100-48S24W	18-72	24	4.2	100	88%	1000

WCHD100-48S28W	18-72	28	3.6	100	88%	1000
WCHD100-48S36W	18-72	36	2.8	200	86%	1000
WCHD100-48S48W	18-72	48	2.1	200	86%	1000
WCHD100-110S3V3	66-160	3.3	20	50	87%	10000
WCHD100-110S5	66-160	5.05	20	50	87%	10000
WCHD100-110S9	66-160	9	11.1	100	86%	2200
WCHD100-110S12	66-160	12	8.3	100	86%	2200
WCHD100-110S15	66-160	15	6.7	100	86%	2200
WCHD100-110S18	66-160	18	5.6	100	86%	2200
WCHD100-110S24	66-160	24	4.2	100	86%	1000
WCHD100-110S28	66-160	28	3.6	100	85%	1000
WCHD100-110S36	66-160	36	2.8	200	86%	1000
WCHD100-110S48	66-160	48	2.1	200	86%	1000
WCHD100-110S5W	45-160	5.05	20	50	86%	10000
WCHD100-110S12W	45-160	12	8.3	100	85%	2200
WCHD100-110S15W	45-160	15	6.7	100	85%	2200
WCHD100-110S24W	45-160	24	4.2	100	85%	1000
WCHD100-110S28W	45-160	28	3.6	100	85%	1000
WCHD100-110S48W	45-160	48	2.1	200	85%	1000
WCHD150-12S3V3	9-18	3.3	30	50	87%	10000
WCHD150-12S5	9-18	5.05	30	50	87%	10000
WCHD150-12S9	9-18	9	16.7	100	85%	2200
WCHD150-12S12	9-18	12	12.5	100	85%	2200
WCHD150-12S15	9-18	15	10	100	85%	2200
WCHD150-12S18	9-18	18	8.3	100	85%	2200
WCHD150-12S24	9-18	24	6.3	100	85%	1000
WCHD150-12S28	9-18	28	5.4	100	85%	1000
WCHD150-12S36	9-18	36	4.2	200	85%	1000
WCHD150-12S48	9-18	48	3.1	200	85%	1000
WCHD150-24S3V3	18-36	3.3	30	50	87%	10000

WCHD150-24S5	18-36	5.05	30	50	87%	10000
WCHD150-24S9	18-36	9	16.7	100	86%	2200
WCHD150-24S12	18-36	12	12.5	100	86%	2200
WCHD150-24S15	18-36	15	10	100	86%	2200
WCHD150-24S18	18-36	18	8.3	100	86%	2200
WCHD150-24S24	18-36	24	6.3	100	86%	1000
WCHD150-24S28	18-36	28	5.4	100	85%	1000
WCHD150-24S36	18-36	36	4.2	200	86%	1000
WCHD150-24S48	18-36	48	3.1	200	86%	1000
WCHD150-24S3V3W	9-36	3.3	30	50	86%	10000
WCHD150-24S5W	9-36	5.05	30	50	86%	10000
WCHD150-24S9W	9-36	9	16.7	100	85%	2200
WCHD150-24S12W	9-36	12	12.5	100	85%	2200
WCHD150-24S15W	9-36	15	10	100	85%	2200
WCHD150-24S18W	9-36	18	8.3	100	85%	2200
WCHD150-24S24W	9-36	24	6.3	100	85%	1000
WCHD150-24S28W	9-36	28	5.4	100	85%	1000
WCHD150-24S36W	9-36	36	4.2	200	85%	1000
WCHD150-24S48W	9-36	48	3.1	200	85%	1000
WCHD150-48S3V3	36-72	3.3	30	50	87%	10000
WCHD150-48S5	36-72	5.05	30	50	87%	10000
WCHD150-48S9	36-72	9	16.7	100	86%	2200
WCHD150-48S12	36-72	12	12.5	100	86%	2200
WCHD150-48S15	36-72	15	10	100	86%	2200
WCHD150-48S18	36-72	18	8.3	100	86%	2200
WCHD150-48S24	36-72	24	6.3	100	88%	1000
WCHD150-48S28	36-72	28	5.4	100	88%	1000
WCHD150-48S36	36-72	36	4.2	200	87%	1000
WCHD150-48S48	36-72	48	3.1	200	86%	1000
WCHD150-48S3V3W	18-72	3.3	30	50	87%	10000



WCHD150-48S5W	18-72	5.05	30	50	87%	10000
WCHD150-48S9W	18-72	9	16.7	100	86%	2200
WCHD150-48S12W	18-72	12	12.5	100	86%	2200
WCHD150-48S15W	18-72	15	10	100	86%	2200
WCHD150-48S18W	18-72	18	8.3	100	86%	2200
WCHD150-48S24W	18-72	24	6.3	100	88%	1000
WCHD150-48S28W	18-72	28	5.4	100	88%	1000
WCHD150-48S36W	18-72	36	4.2	200	87%	1000
WCHD150-48S48W	18-72	48	3.1	200	86%	1000
WCHD150-110S3V3	66-160	3.3	30	50	87%	10000
WCHD150-110S5	66-160	5.05	30	50	87%	10000
WCHD150-110S9	66-160	9	16.7	100	86%	2200
WCHD150-110S12	66-160	12	12.5	100	86%	2200
WCHD150-110S15	66-160	15	10	100	86%	2200
WCHD150-110S18	66-160	18	8.3	100	86%	2200
WCHD150-110S24	66-160	24	6.3	100	86%	1000
WCHD150-110S28	66-160	28	5.4	100	85%	1000
WCHD150-110S36	66-160	36	4.2	200	86%	1000
WCHD150-110S48	66-160	48	3.1	200	86%	1000
WCHD150-110S5W	45-160	5.05	30	50	86%	10000
WCHD150-110S12W	45-160	12	12.5	100	85%	2200
WCHD150-110S15W	45-160	15	10	100	85%	2200
WCHD150-110S24W	45-160	24	6.3	100	85%	1000
WCHD150-110S28W	45-160	28	5.4	100	85%	1000
WCHD150-110S48W	45-160	48	3.1	200	85%	1000
WCHD300-24S12M	20-36	12	25	100	86%	2200
WCHD300-24S24M	20-36	24	12.5	100	86%	1000
WCHD300-24S28M	20-36	28	10.7	100	85%	1000
WCHD300-24S48M	20-36	48	6.3	200	86%	1000
WCHD300-48S12M	36-72	12	25	100	87%	2200

WCHD300-48S24M	36-72	24	12.5	100	90%	1000
WCHD300-48S28M	36-72	28	10.7	100	90%	1000
WCHD300-48S48M	36-72	48	6.3	200	86%	1000
WCHD300-110S12M	66-154	12	25	100	86%	2200
WCHD300-110S24M	66-154	24	12.5	100	86%	1000
WCHD300-110S28M	66-154	28	10.7	100	85%	1000
WCHD300-110S48M	66-154	48	6.3	200	86%	1000

注 3： 我公司该系列产品按照功率进行分类，分别为 75W、100W、150W、300W（尾缀加 M）；可参考“机械图及管脚说明”来确定端子连接形式和产品名称；以上表格中仅列出典型型号，我公司可根据客户需求信息（包括功率、输入电压、输出电压、负载特性等）来单独设计。

## 输出调节应用（TRIM Function）

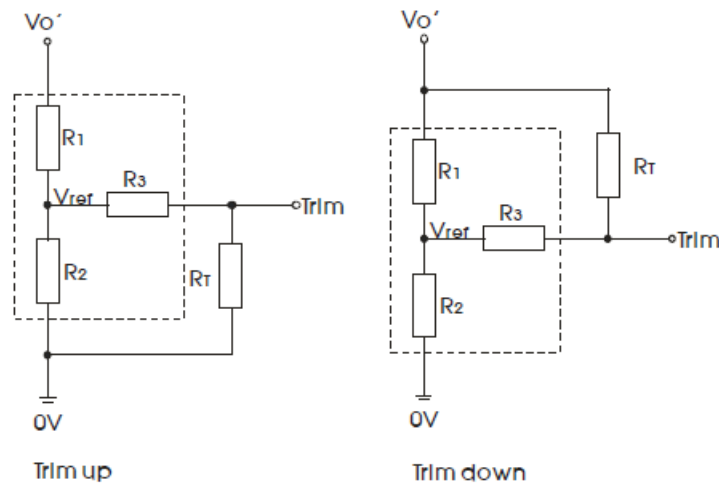

$$\begin{aligned}
 \text{up: } R_T &= \frac{TR_2}{R_2 - T} - R_3 & T &= \frac{V_{ref}}{V_o' - V_{ref}} \cdot R_1 \\
 \text{down: } R_T &= \frac{TR_1}{R_1 - T} - R_3 & T &= \frac{V_o' - V_{ref}}{V_{ref}} \cdot R_2
 \end{aligned}$$

Vout (V)	R1 (KΩ)	R2 (KΩ)	R3 (KΩ)	Vref (V)
3.3	3.32	2.0	8.2	1.24
5	2.55	2.49	8.2	2.5
12	9.53	2.49	12	2.5
15	12.5	2.49	15	2.5
24	21.5	2.49	20	2.5

注 4： 以上仅为典型值，若有特殊使用方法，可在产品单页说明书或者应用手册中补充说明：

## 机械图及管脚说明 (Mechanical Chart、Pins) (Unit: mm)

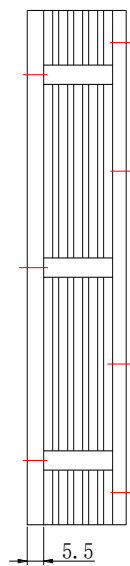
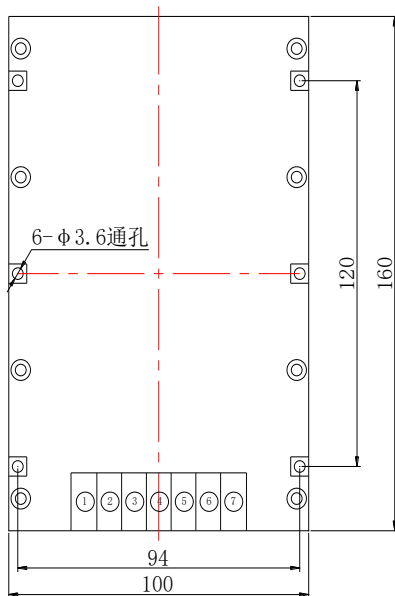
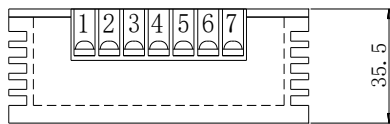
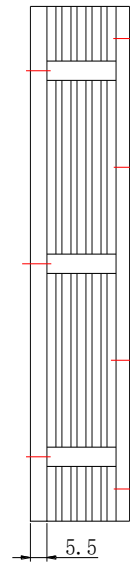
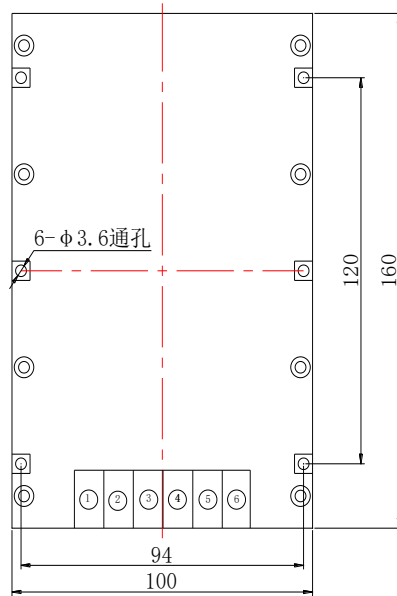
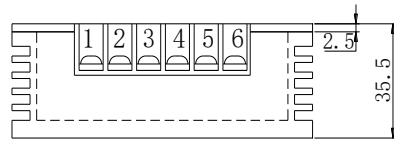

第一种：标准型管脚定义（默认，如下所示，如 WCHD75-24S24）

项目	输入端		输出端			
管脚	1	2	3	4	5	6
定义	+Vin	-Vin	-Vo	-Vo	+Vo	+Vo
说明	输入正	输出负	输出负	输出负	输出正	输出正
备注	须正确区分正负极					

第二种：尾缀带 C 型管脚定义（如下所示，含输入遥控和输出电压可调功能,如 WCHD100-24S12C）

项目	输入端			输出端			
管脚	1	2	3	4	5	6	7
定义	+Vin	-Vin	CNT	NC	Trim	-Vo	+Vo
说明	输入正	输出负	遥控	无连接 空管脚	输出电压 可调	输出负	输出正
备注	须正确区分正负极		默认为正 逻辑控制 方式；		允许调节 范围为 ±10%；		

第三种：110V 输入铁路专用电源管脚定义（如下所示,如 WCHD150-110S24）

项目	输入端			输出端			
管脚	1	2	3	4	5	6	7
定义	+Vin	-Vin	FG	-Vo	-Vo	+Vo	+Vo
说明	输入正	输出负	地线	输出负	输出负	输出正	输出正
备注	须正确区分正负极						

注 5： 外壳安装定位尺寸公差按 GB/T1804-2000 F 级标准，外型尺寸公差按 GB/T1804-2000 C 级标准；

注 6：

- 1) 端子管脚顺序依次从左往右；
- 2) 安装孔数量 6 个，均为通孔（壳体内部深度约 5~7mm），推荐采用 M3 螺钉固定电源机壳；